

ISSUE 8; September 2018

Description

- The CX1H TF quartz crystal is manufactured using Statek's photolithographic process and then sealed within a rugged ceramic package for high shock resistance and low ageing. This high quality tuning fork resonator is intended for use in Series (two cascaded inverters) oscillators.
- -C SM1 Ceramic lid SM1
- Gold Plated (RoHS Compliant)
- -C SM4 Ceramic lid SM4
- Solder Plated (RoHS Compliant)
- -C SM5 Ceramic lid SM5
- Solder Dipped (RoHS Compliant)
- -SM1 Glass lid SM1
- Gold Plated (RoHS Compliant)
- -SM4 Glass lid SM4
- Solder Plated (RoHS Compliant)
- -SM5 Glass lid SM5
- Solder Dipped (RoHS Compliant)
- FEATURES:
Miniature tuning fork design
High shock resistance
Designed for low power applications
Compatible with hybrid or PC board packaging
Low ageing
- Please note that all data is only valid at 25°C unless otherwise stated.

Frequency Parameters

- Frequency 10.0kHz to 600.0kHz
- Frequency Tolerance ±30.00ppm to ±5,000.00ppm
- Tolerance Condition @ 25°C
- Ageing ±5ppm max in 1st year
- Temperature Coefficient (k): -0.035/°C²
- Frequency (f) at temperature (T) deviation from frequency (fo) at turning point temperature (To): $(f - fo)/fo = k(T - To)^2$
- Note: Tighter tolerances are available - please contact an IQD Sales Office
- Note: Other turning points are available - please contact an IQD Sales Office

Electrical Parameters

- Shunt Capacitance (C0) 2pF max
- Drive Level 1.5µW max 10-24.999kHz,
3µW max 25-600
- Maximum Motional Resistance:
2 x typical (10-169.999kHz)
2.5 x typical (170-600kHz)
- Quality Factor (Q): Minimum is 0.25 x typical

Operating Temperature Ranges

- -10 to 70°C
- -40 to 85°C
- -55 to 125°C

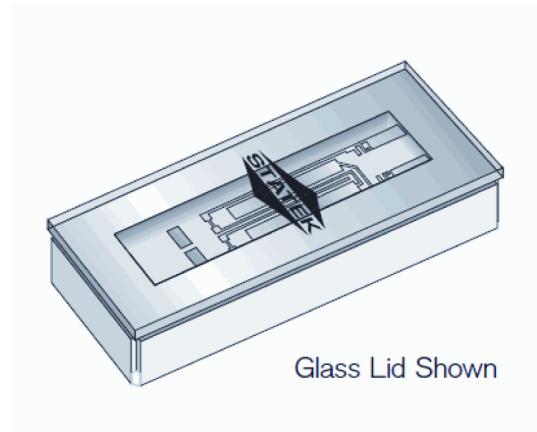

Glass Lid Shown

Outline (mm) -SM1 = Glass lid SM1

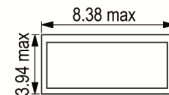

Height (H) = Glass Lid	Ceramic Lid
SM1	1.65 max 1.78 max
SM2	1.70 max 1.83 max
SM3	1.78 max 1.90 max
SM4	1.70 max 1.83 max
SM5	1.78 max 1.90 max

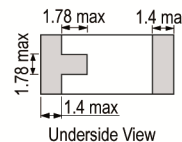
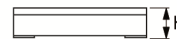

Solder Pad Layout

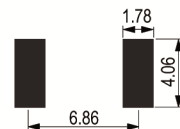

CX1H Typical Motional Resistance

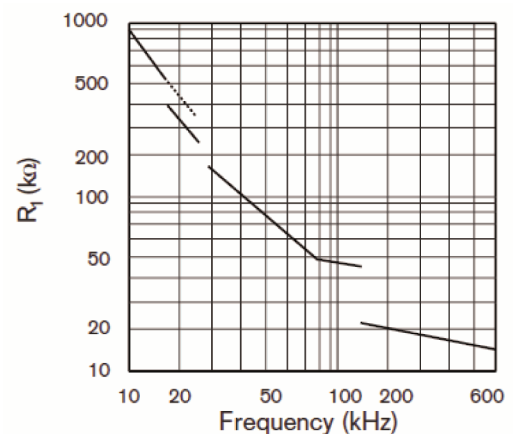

Sales Office Contact Details:

UK: +44 (0)1460 270200
Germany: 0800 1808 443

France: 0800 901 383
USA: +1.760.318.2824

Email: info@iqdfrequencyproducts.com
Web: www.iqdfrequencyproducts.com

Environmental Parameters

- Storage Temperature Range: -55 to 125°C
- Shock: 1000G, 1ms, 1/2 sine
- Vibration: 20G RMS, 10-2000Hz
- Note: Higher shock and vibration available - please contact an IQD Sales Office

Manufacturing Details

- PACKAGE HANDLING: The CX1H SMD crystal is hermetically sealed in a ceramic package. Normal handling and soldering precautions for small, low thermal mass parts are adequate when installing or testing these crystals. CX1H SMD crystals may be reflow soldered at a maximum soldering process temperature of 260°C for 20sec max.
- RoHS Terminations Various
- RoHS Reflow 260degC 20s

Ordering Information

- Frequency*
- Model*
- Lid Variant*
- Termination Variant*
- Frequency Tolerance (@25°C)*
- Operating Temperature Range*
- Load Capacitance
- Overtone
- (*minimum required)
- Lid Variants:
 - Blank = Glass
 - C = Ceramic
- Termination Variants:
 - SM1 = Gold Plated
 - SM4 = Solder Plated
 - SM5 = Solder Dipped

(Note: Non-RoHS compliant terminations also available - SM2 = Pb Solder Plated / SM3 = Pb Solder Dipped - please contact an IQD Sales Office)
- Example
40.0kHz CX1H TF C SM1
100/-/10 to 70C/SR FUND

Compliance

- RoHS Status (2011/65/EU) Optional
- REACH Status Compliant
- MSL Rating (JDEC-STD-033): Not Applicable

Packaging Details

- Pack Style: Reel Tape & reel in accordance with EIA-481-D
Pack Size: 1,000
- Pack Style: Tray Supplied on a tray
Pack Size: 1

Sales Office Contact Details:

UK: +44 (0)1460 270200
Germany: 0800 1808 443

France: 0800 901 383
USA: +1.760.318.2824

Email: info@iqdfrequencyproducts.com
Web: www.iqdfrequencyproducts.com

CX1H Typical Motional Capacitance

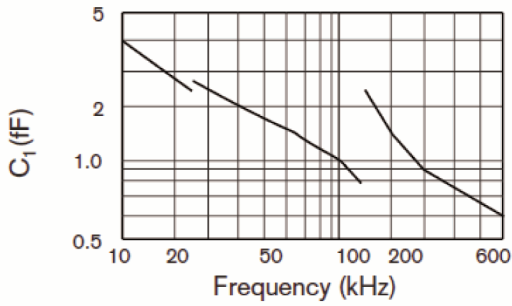

CX1H Typical Quality Factor

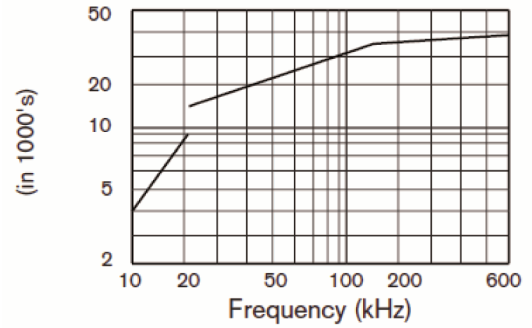

CX1H Typical Turning Point Temperature

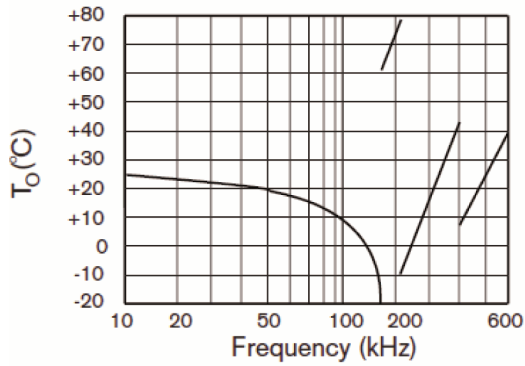

Conventional Series Oscillator Circuit

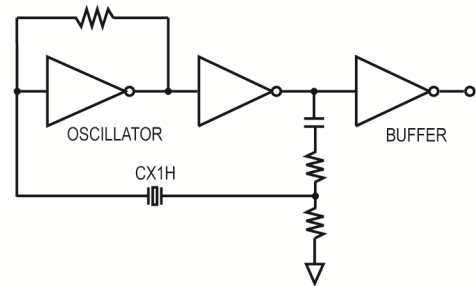

Sales Office Contact Details:

UK: +44 (0)1460 270200
Germany: 0800 1808 443

France: 0800 901 383
USA: +1.760.318.2824

Email: info@iqdfrequencyproducts.com
Web: www.iqdfrequencyproducts.com